

KENWOOD

CD PLAYER

DP-M5540

INSTRUCTION MANUAL

KENWOOD CORPORATION



B60-0738-00 (K,X,Y,M) [A]
93/12 11 10 9 8 7 6

Introduction

Your choice of this product indicates that you are a devotee to excellence in sound reproduction.

We appreciate your patronage and take pride in the long tradition of quality components that our company represents.

So that you can get the most out of your unit, we suggest that you take the time to read through this manual before you hook up and operate your system. This will acquaint you with operating features and system-connection considerations so that your listening pleasure will be enhanced right from the start. You will notice that in all aspects of planning, engineering, styling, operating convenience and adaptability we have sought to anticipate your needs and desires.

Keep this manual handy for future reference.

For your records

Record the serial number, found on the back of the unit, in the spaces designated on the warranty card, and in the space provided below. Refer to the model and serial numbers whenever you call upon your dealer for information or service on this product.

Model _____ Serial Number _____

Unpacking

Unpack the unit carefully and make sure that all accessories are put aside so they will not be lost.

Examine the unit for any possibility of shipping damage. If your unit is damaged or fails to operate, notify your dealer immediately. If your unit was shipped to you directly, notify the shipping company without delay. Only the consignee (the person or company receiving the unit) can file a claim against the carrier for shipping damage.

We recommend that you retain the original carton and packing materials for use should you transport or ship the unit in the future.

The marking of products using lasers (Except for some areas).

**CLASS 1
LASER PRODUCT**

This label is attached to the rear panel and says that the component uses laser beams that have been classified as Class 1. It means that the unit is utilizing laser beams that are of a weaker class. There is no danger of hazardous radiation outside the unit.

For the USA

CAUTION:

Use of controls or adjustments or performance of procedures other than those specified herein may result in hazardous radiation exposure.

In compliance with Federal Regulations, following are reproductions of labels on, or inside the product relating to laser product safety.

KENWOOD CORPORATION
SHIONOGI SHIBUYA BUILDING 17-5,
2-CHOME, SHIBUYA, SHIBUYA-KU,
TOKYO, JAPAN

KENWOOD CORP. CERTIFIES THIS EQUIPMENT
CONFORMS TO DHHS REGULATIONS NO. 21 CFR
1040. 10, CHAPTER I, SUBCHAPTER J.

Location: Back Panel

Accessories

- Audio cord 1
- System control cord 1



- Magazine 1
(with 6 disc trays)



For the unit with a European AC plug in areas other than Europe.
(Except for some areas)



Contents

Caution: Read the pages marked carefully to ensure safe operation.

Introduction	2	Normal playback	14
Before applying power	3	Program playback	16
Safety precautions	3	Repeat playback	18
IMPORTANT SAFEGUARDS	4	Random playback	19
Before operation	6	Editing	20
Playing compact discs	8	Time display and timer playing	22
System connections	10	In case of difficulty	23
Controls and indicators	12	Specifications	24

⚠ Caution: Read this page carefully to ensure safe operation.

Before applying power

For the U.S.A. and Canada

Important!

Units shipped to the U.S.A. and Canada are designed for operation on 120 volts AC only.

CAUTION: TO PREVENT ELECTRIC SHOCK DO NOT USE THE AC PLUG WITH AN EXTENSION CORD, RECEPTACLE OR OTHER OUTLET UNLESS THE BLADES CAN BE FULLY INSERTED TO PREVENT BLADE EXPOSURE.

For the United Kingdom

Important!

Units shipped to the U.K. are designed for operation on 240 volts AC only.

The mains plug must be removed from the wall socket prior to any internal examination.

The wires in this mains lead are coloured in accordance with the following code:

Blue Neutral
Brown Live

The wires in this mains lead must be connected to the terminals in the plug as follows:

Wire colour	Plug terminal marking
Blue	N or Black
Brown	L or Red

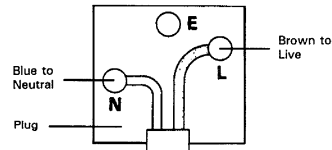

Notes:

1. If a 13-amp plug is used, this must be fitted with a 5-amp fuse.
2. If a 3-pin plug with earthing contact is used, no wire must be connected to the E terminal.

For Australia and Europe

Important!

Units shipped to Australia are designed for operation on 240 V AC only.

Units shipped to Europe are designed for operation on 230 V AC only.

For other countries

Important!

Units shipped to countries other than the above countries are equipped with an AC voltage selector switch on the rear panel. Refer to the following paragraph for the proper setting of this switch.

AC voltage selection

This unit operates on 110-120 or 220-240 volts AC. The AC voltage selector switch Type A or Type B on the rear panel is set to the voltage that prevails in the area to which the unit is shipped. Before connecting the power cord to your AC outlet, make sure that the setting position of this switch matches your line voltage. If not, it must be set to your voltage in accordance with the following direction.

Note:

Our warranty does not cover damage caused by excessive line voltage due to improper setting of the AC voltage selector switch.

AC voltage selector switch

Type A

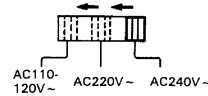



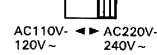

Type B



Move switch lever to match your line voltage with a small screwdriver or other pointed tool.

Safety precautions

WARNING: TO PREVENT FIRE OR ELECTRIC SHOCK, DO NOT EXPOSE THIS APPLIANCE TO RAIN OR MOISTURE.

 	CAUTION RISK OF ELECTRIC SHOCK DO NOT OPEN	CAUTION: TO REDUCE THE RISK OF ELECTRIC SHOCK, DO NOT REMOVE COVER (OR BACK). NO USER-SERVICEABLE PARTS INSIDE, REFER SERVICING TO QUALIFIED SERVICE PERSONNEL.
	THE LIGHTNING FLASH WITH ARROWHEAD SYMBOL, WITHIN AN EQUILATERAL TRIANGLE, IS INTENDED TO ALERT THE USER TO THE PRESENCE OF UNINSULATED "DANGEROUS VOLTAGE" WITHIN THE PRODUCT'S ENCLOSURE THAT MAY BE OF SUFFICIENT MAGNITUDE TO CONSTITUTE A RISK OF ELECTRIC SHOCK TO PERSONS.	
	THE EXCLAMATION POINT WITHIN AN EQUILATERAL TRIANGLE IS INTENDED TO ALERT THE USER TO THE PRESENCE OF IMPORTANT OPERATING AND MAINTENANCE (SERVICING) INSTRUCTIONS IN THE LITERATURE ACCOMPANYING THE APPLIANCE.	

IMPORTANT SAFEGUARDS

⚠ Caution : Read this page carefully to ensure safe operation.

Please read all of the safety and operating instructions before operating this unit. For best results, follow all warnings placed on the unit and adhere to the operating and use instructions. These safety and operating instructions should be retained for future reference.

1. Power sources — The unit should be connected to a power supply only of the type described in the operating instructions or as marked on the appliance.

2. Power-cord protection — Power-supply cords should be routed so that they are not likely to be walked on or pinched by items placed upon or against them, pay particular attention to cords at plugs, convenience receptacles, and the point where they exit from the unit.

Never pull or stretch the cord.



3. Grounding or polarization — The precautions should be taken so that the grounding or polarization means of this unit is not defeated.

4. Ventilation — The unit should be situated so that its location or position does not interfere with its proper ventilation.

To maintain good ventilation, do not put records or a table-cloth on the unit. Place the unit at least 10 cm away from the walls.

Do not use the unit on a bed, sofa, rug or similar surface that may block the ventilation openings.

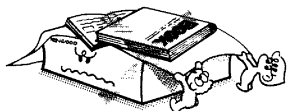

5. Water and moisture — The unit should not be used near water — for example, near a bathtub, washbowl, kitchen sink, laundry tub, in a wet basement, or near a swimming pool, etc.

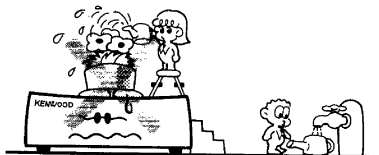

6. Temperature — The unit may not function properly if used at extremely low, or freezing temperatures. The ideal ambient temperature is above +5°C (41°F).

7. Heat — The unit should be situated away from heat sources such as radiators, heat registers, stoves, or other units (including amplifiers) that produce heat.

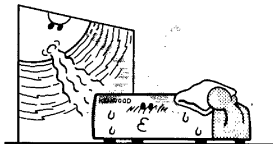

8. Electric shock — Care should be taken so that objects do not fall and liquid is not spilled into the enclosure through openings. If a metal object, such as a hair pin or a needle, comes into contact with the inside of this unit, a dangerous electric shock may result. For families with children, never permit children to put anything, especially metal, inside this unit.

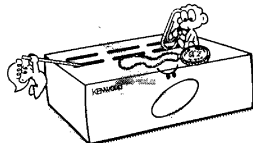

9. Enclosure removal — Never remove the enclosure. If the internal parts are touched accidentally, a serious electric shock might occur.

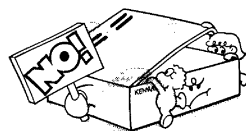

10. Magnetic fields — Keep the unit away from sources of magnetic fields such as TV sets, speaker systems, radios, motorized toys or magnetized objects.

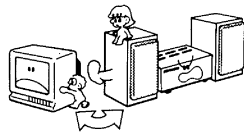

11. Cleaning — Do not use volatile solvents such as alcohol, paint thinner, gasoline, or benzene, etc. to clean the cabinet. Use a clean dry cloth.

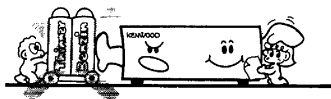

⚠ Caution : Read this page carefully to ensure safe operation.

12. Carts and stands — An appliance and cart combination should be moved with care. Quick stops, excessive force, and uneven surfaces may cause the appliance and cart combination to overturn.



13. Nonuse periods — The power cord of the unit should be unplugged from the outlet when left unused for a long period of time.

14. Abnormal smell — If an abnormal smell or smoke is detected, immediately turn the power OFF and pull out the power cord. Contact your dealer or nearest service center.

POWER OFF!

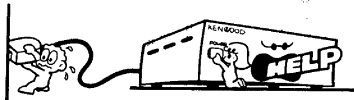

15. Damage requiring service — The unit should be serviced by qualified service personnel when:

- A.** The power-supply cord or the plug has been damaged; or
- B.** Objects have fallen, or liquid has been spilled into the unit; or
- C.** The unit has been exposed to rain; or
- D.** The unit does not appear to operate normally or exhibits a marked change in performance; or
- E.** The unit has been dropped, or the enclosure damaged.

16. Servicing — The user should not attempt to service the unit beyond that described in the operating instructions. All other servicing should be referred to qualified service personnel.

17. Outdoor antenna grounding — If an outside antenna is connected to the receiver, be sure the antenna system is grounded so as to provide some protection against voltage surges and built up static charges. Section 810 of the National Electrical Code, ANSI/NFPA 70, provides information with respect to proper grounding of the mast and supporting structure, grounding of the lead-in wire to an antenna discharge unit, size of grounding con-

ductors, location of antenna-discharge unit, connection to grounding electrodes, and requirements for the grounding electrode. See Figure.

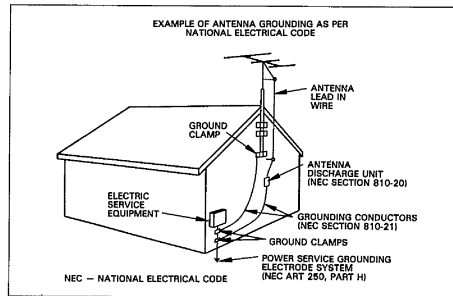

18. Power lines — An outdoor antenna should be located away from power lines.

Notes:

- 1. Item 3 is not required except for grounded or polarized equipment.
- 2. Item 17 and 18 are not required except for units provided with antenna terminals.
- 3. Item 17 complies with UL in the U.S.A.

Before operation

■ Beware of condensation

When water vapor comes into contact with the surface of cold material, water drops are produced. If condensation occurs, correct operation may not be possible, or the unit may not function correctly. This is not a malfunction, however, and the unit should be dried. (To do this, turn the POWER switch ON and leave the unit as it is for several hours.)

Be especially careful in the following conditions:

- When the unit is brought from a cold place to a warm place, and there is a large temperature difference.
- When a heater starts operating.
- When the unit is brought from an air-conditioned place to a place of high temperature with high humidity.
- When there is a large difference between the internal temperature of the unit and the ambient temperature, or in conditions where condensation occurs easily.

■ Note related to transportation and movement

Carry out the following operations before transporting or moving this unit.

1. Remove discs and the magazine from the unit and turn the power on.
2. Wait a few seconds to check that the display appears as shown in the illustration at the right.
3. Turn the power off.

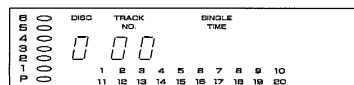

■ Disc handling precautions

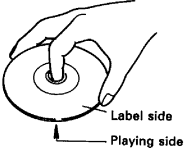

Handling
Hold compact disc so that you do not touch the playing surface.

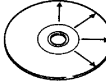

Cleaning
If fingerprints or foreign matter become attached to the disc, lightly wipe the disc with a soft cotton cloth (or similar) from the center of the disc outwards in a radial manner. Never use chemical solvents, such as thinner, benzine, etc. and conventional record cleaner aerosols.

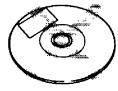

Do not attach paper or tape to either the playing side or the label side of compact discs.

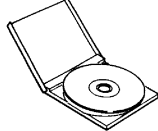

Storage
When a disc is not to be played for a long period of time, remove it from the CD player and store it in its case.

■ Types of disc which can be played with this unit

Disc type	Disc size
CD (general compact disc)	12 cm
CDV (CD with video) audio section	12 cm
CD single	8 cm

The 8 cm CD adaptor on sale cannot be used with this unit. If it is used with this unit, it is possible that the disc or CD player will be damaged.

- If it is required to place CD single discs using a magazine, please purchase and use the optional CDM-608 CD single disc magazine.
- In the case of CDV the time display and music calendar display are all for the audio section only.

Playing compact discs

■ Insert a disc into the magazine

1. Press the magazine lock button and take out the disc tray.
2. With the label upwards, correctly load the disc into the disc tray.
3. Slide the disc tray horizontally along the left and right side grooves of the magazine and insert it completely.

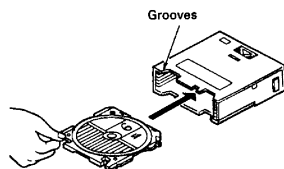
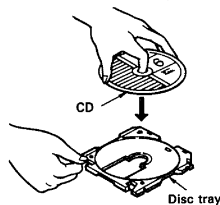
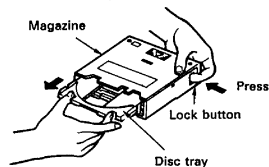

- It is not necessary to press the lock button.

Notes on handling the magazine:

1. If the disc tray is inserted at an angle into the magazine, the unit will not operate.



3. Always keep the magazine loaded with six disc trays.
4. Store magazine and discs avoiding places of direct sunlight, high temperature and high humidity.
5. Do not drop, apply excessive force or subject shock to the magazine or tray.
6. Do not use benzine, paint thinner or cleaning detergents. These may damage surfaces.

2. The disc must be only inserted in the magazine after it has been inserted in the tray. If it is inserted directly the unit will not operate.

Care in handling:

1. There are openings in the disc trays for signal reading. These openings leave part of the shiny side of the disc exposed. Be careful not to touch the shiny surface of the disc.
2. Never put a single disc directly into the magazine through these openings.
3. Always keep the magazine loaded with six disc trays.
4. When removing or inserting disc trays, hold the magazine leveled.
5. Do not expose the magazine to high temperature or direct sunlight.

How to use labels

Be sure to put the provided labels in the designated places. Placement of the labels or tape in the wrong place may cause a malfunction.

Note:
When labeling the magazine, never put labels on top of each other.

■ How to use the magazine

Loading the magazine

1. Press the POWER switch to turn on the player.
2. Insert a magazine containing discs.
3. Firmly press the magazine until a click can be heard.

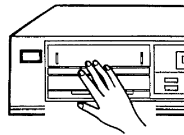
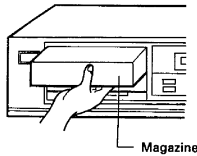

Ejecting the magazine

1. Press the EJECT key.
2. Remove the magazine towards you.

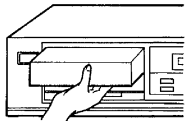
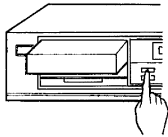

● Lighting of indicators

When the magazine is inserted:



→ All of the disc indicators light up.



When a disc starts to be played:

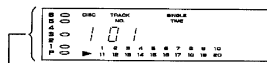

→ Only the disc indicators of present discs light up.

Notes:

1. When the power is switched on, if a magazine and discs are already inserted, this unit will automatically start to play.
2. Hold the magazine by the central section when inserting or removing it.
3. When the unit is to be transported, be sure to remove the magazine pack from the main body.
4. It will not operate if the key of a non-illuminated DISC NO. is pressed.

■ How to load a compact disc (for PLUS ONE tray)

Press the OPEN/CLOSE key to open the tray.
Load the disc with the labeled side up.

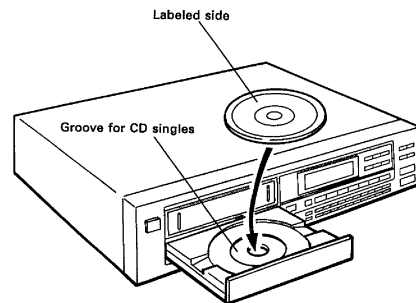

Notes:

1. Make sure to load the disc with the labeled side up. The disc cannot be played if it is placed upside down.
2. Do not place objects other than discs on the disc tray.
3. As this unit employs auto-close function, be sure to place a disc correctly.

System connections

Make connection as shown below. When connecting the related system components, refer also to the instruction manuals of the related components.
Do not plug in the power lead until all connections are completed.

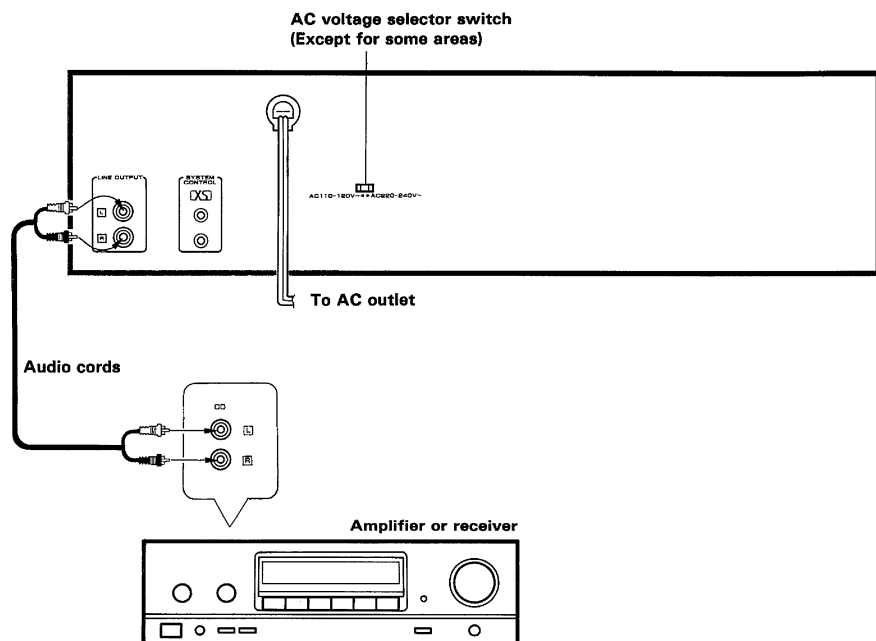

Notes:

1. Connect all cords firmly. If connections are loose there could be loss of sound or noise produced.
2. Do not connect up a power source which is larger than that indicated on the socket at the rear of the unit.
3. When plugging and unplugging connection cords, be sure to first remove the power cord from the AC outlet. Plugging/unplugging connection cords without removal of the power cord can cause malfunctions or damage to the unit.

System control connections

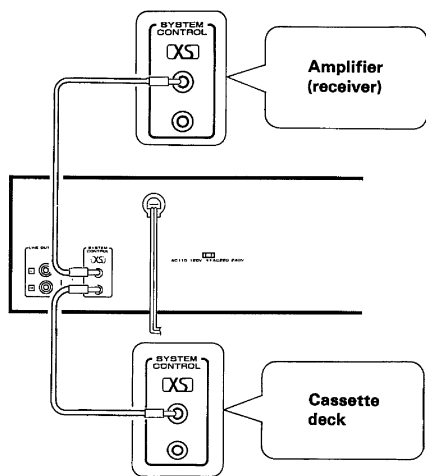

Note:
When using the system control function, be sure to connect the LINE OUTPUT jacks of this unit to the input jacks of the amplifier using audio cords.

System control connection (Except for some areas)

When connected to an amplifier or receiver having KENWOOD SYSTEM CONTROL terminals, system operation is made possible. For details, refer to the instruction manual of the amplifier or receiver.
If your amplifier or receiver is not equipped with the SYSTEM CONTROL terminals, do not connect anything to any SYSTEM CONTROL terminal.
Do not connect the unit in any system configuration other than specified.

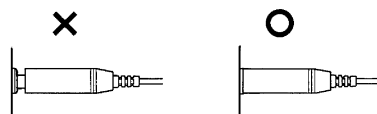

- Be sure to insert the system control cord plugs fully into the SYSTEM CONTROL terminals.

■ CCRS

By connecting the SYSTEM CONTROL jack of this unit with the "XS" SYSTEM CONTROL jack of a KENWOOD cassette deck, CCRS recording can be carried out.
The CCRS function is used when recording from a compact disc to a tape in a cassette deck, and operates to adjust the cassette deck's recording level to the optimum setting according to the playing level of the compact disc. For details on the CCRS function, refer to the instruction manual provided with your cassette deck.

■ CCRS recording

1. Select the CD input with the input selector switch of the amplifier or receiver.
2. Load a CD into the CD player.
3. Insert the tape to be used for recording into the cassette deck.
4. Select the desired DISC No. to record on the cassette deck by the Disc selector keys on this unit.
5. Press the CCRS key on the cassette deck.

Note:
1. In PGM (program) mode, CCRS recording cannot be performed.
2. CCRS recording cannot be performed for multiple play of many discs. For each disc, perform the operations given in procedures 4 and 5.

Controls and indicators

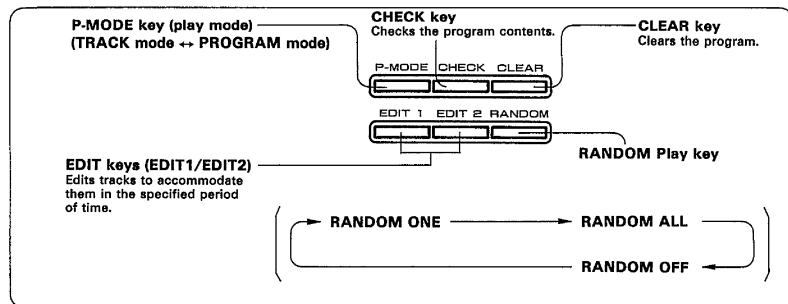
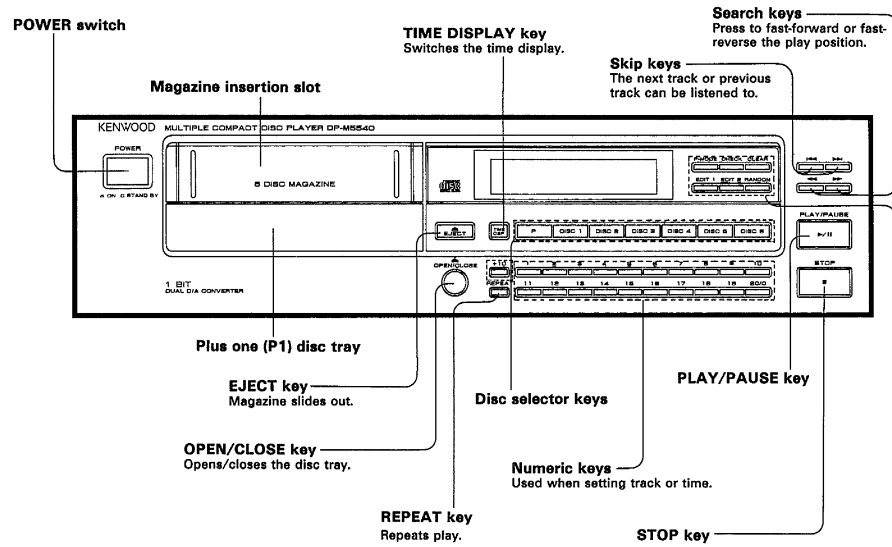

Display window

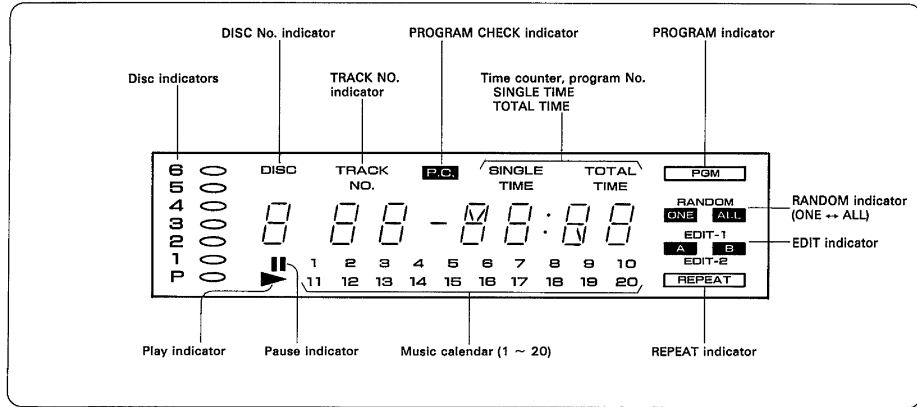

Normal playback

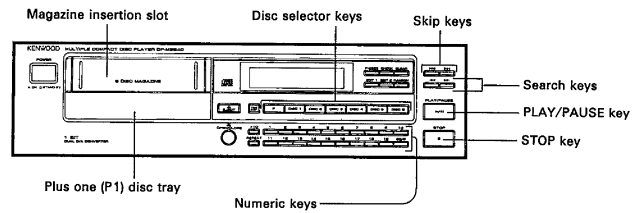

■ To play all the CDs

1 Load a disc.

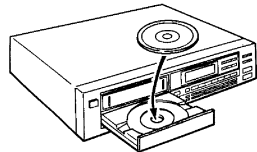

- Also load discs into the magazine.

2 Play the discs.

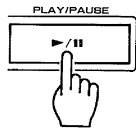

- The discs are played in the order P → 1 → 2 → 3 → 4 → 5 → 6.
- After all discs have been played, the unit enters stop mode.
- If a Disc selector key is pressed during playback, the currently playing tune stops and playback starts at the beginning of the selected disc.
- If a tray does not contain a CD, the CD in the next tray is played.

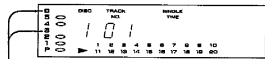
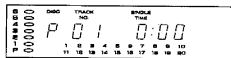

These discs are not present.

■ To play only one CD

1 Load a disc.

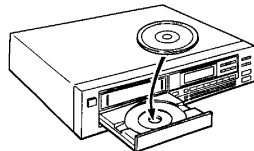

- Remove the magazine from the unit.

2 Play the disc.

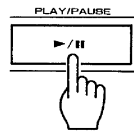

- When playback is finished, the unit enters stop mode.

■ To pause playback

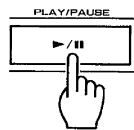

- Press again to resume playback.

■ To stop playback

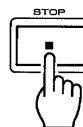

■ To start playback from a desired CD

1 Load a disc (into P1 or the magazine).

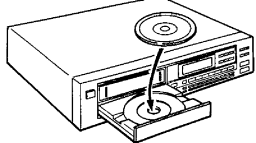

2 Select the disc.

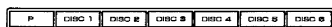

- Playback starts from the beginning of the selected disc.
- When the disc finishes playing, playback of the next CD begins.
- If you use the Disc selector keys to select a disc while another disc is playing, the current disc stops and the selected disc starts playing.

■ Fast-forward/fast-reverse operation

To fast-forward or fast-reverse the disc



- Play continues from where you release the key.

■ To play a desired tune

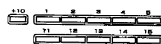

- Select the desired tune with the numeric keys. If the tune number is 21 or greater, press [+10] first.
Example: To select tune number 25: Press [+10] twice and then [5].
- The tune number is indicated on the display and playback starts.
- If the entered tune number is larger than the number of the last tune on the disc, the last tune is played.

Auto SPACE function

When in the program mode, intervals with no sound of about 4 seconds are created between the programmed tracks. This function is for making use of the DPSS system on the cassette deck.
If "all disc program" has been selected for a particular program number, 4 second intervals are not inserted during play of tracks of that disc.

To skip tunes



- If [SKIP] is pressed once during playback, the player returns to the beginning of the current tune and plays the tune again.

Program playback

You can program tunes for playback in any desired order. Up to 20 tunes can be selected from discs P1 to 6 using tune numbers 1 to 99.

■ Programming procedure

1 Set the player to Program mode.



2 Select a disc.

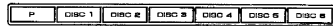

DISC TRACK
NO. 3 0 1

3 Select a tune number.

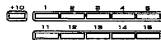

DISC TRACK
NO. 3 1 2

4 Repeat steps 2 and 3.

- If step 3 is omitted, the entire disc selected in step 2 is programmed (the "ALL" indicator lights).
- If more than 20 tunes are entered, the display becomes as follows.

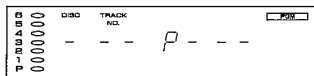

■ To check the program contents



DISC TRACK
NO. P 0 1
P.C. lights

- Each press of the key displays the next tune number and disc number.
- When the CHECK key operation is finished, the display returns to the previous display after about 4 seconds.

■ To change the program contents

1 Display the tune number you want to change.



- Press until the tune number to be changed is displayed.
- The P.C. indicator lights.

2 Select the disc containing the desired tune.

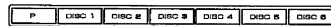

- Select while the P.C. indicator is lit.

3 Select the tune number.



- The programmed tune is changed to the selected tune approximately 4 seconds after the tune number is entered.
- A program cannot be changed during playback.

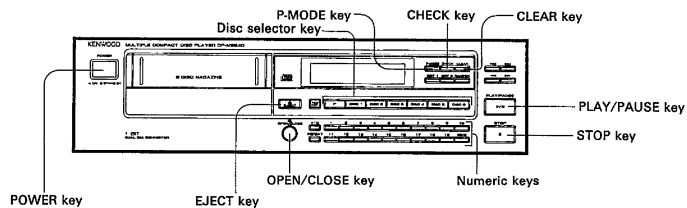

■ To play a program



- When the last tune finishes playing, the unit enters stop mode.

To stop playback



■ To change the last tune number in a program

1 Erase the last tune number.



- Each press erases one tune from the end of the program.

2 Select a disc.



3 Select a tune number.



- The CLEAR key cannot be used to erase programmed tunes during playback.

■ To add a tune to a program

1 Select a disc.



2 Select a tune number.





■ To erase a program

You can erase a program using any of the following operations.



- When pressed a number of times equal to the number of programmed tunes, the entire program is erased.

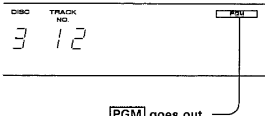

Repeat playback

■ To repeatedly play selected tunes

Repeating selected tunes

1 Set the player to PGM mode.

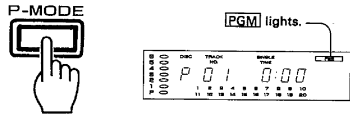

2 Select tunes to be repeated.

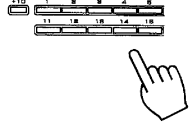

- All selected tunes are played repeatedly.
- When just one tune is selected, only that tune is played repeatedly.

3 Set the player to REPEAT mode.

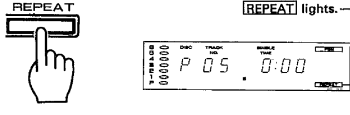

4 Start playback.

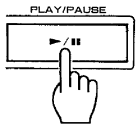

To cancel repeat playback

Press the REPEAT key again.

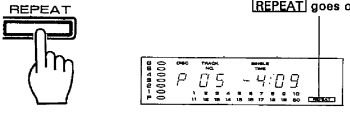

- The player returns to the previous playback mode.

Repeating an entire disc

1 Set the player to TRACK mode.

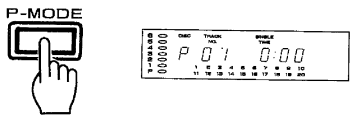

2 Set the player to REPEAT mode.

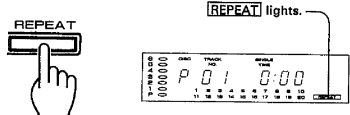

3 Start playback.

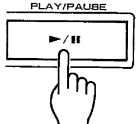

■ To repeatedly play a disc (or several discs)

1 Set the player to Program mode.

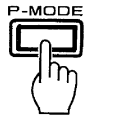

2 Select a disc.



- To repeatedly play more than one disc, press the keys for all the discs you want to include.

3 Press the REPEAT key.

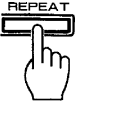

4 Start playback.

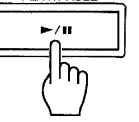

Random playback

Tunes are automatically selected and played at random using one or all of the discs in P1 and the magazine (1 — 6). (Random playback is not possible in program mode.)

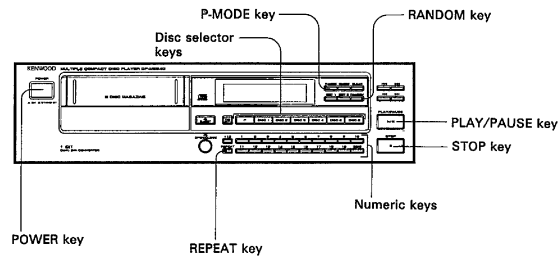

■ Single-disc random playback

1 Select a disc.

2 Start random playback.

- Random playback begins.

RANDOM lights.

■ All-disc random playback

Press twice.

- The selected track No. will light.

■ To cancel random playback

RANDOM goes out.

Note:
Although the same tune from the same CD will not be played twice consecutively, it might be played again later.

Editing

When recording tunes from one or more CDs onto a tape, this function edits the tunes to ensure that the tunes fit within the specified tape length and that the last tune on either side does not get cut off in the middle. Two edit keys, EDIT 1 and EDIT 2, allow you to edit two different discs separately. This is convenient for times when you want to record two tapes in succession. Set the player to TRACK mode before performing the edit operation.

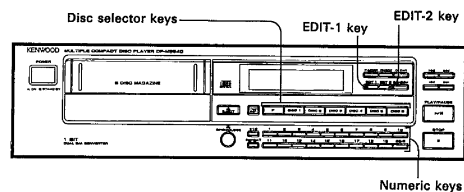

■ To edit a disc

1 Press the EDIT 1 key.



- You cannot use the EDIT 2 key until the first disc has been edited using the EDIT 1 key.

2 Select the disc you want to edit.

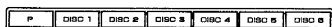

Select one disc.

- Editing using two or more discs at one time is not possible.

3 Enter the tape length.



Examples:
For a C-60 tape: Press ± 10 six times, then press 0 .
For a C-46 tape: Press ± 10 four times, then press 6 .

Editing is carried out as follows.

(1) The specified tape length is divided in half, then as many tunes as will fit in the A file (side A of the tape) are selected starting with the small track numbers.

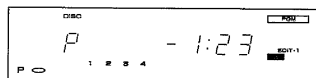

(2) After a few seconds the remaining time left in the A file appears on the display, then the B file (side B of the tape) is edited in the same manner.

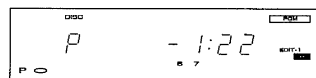

- If you press the stop key or OPEN/CLOSE key while editing is being carried out, editing is interrupted and stops.

Editing completed

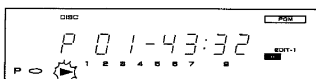

To edit a second disc

Press the EDIT 2 key in step 1, then perform steps 2 and 3 in the same manner as for the first disc.



■ To play an edited program

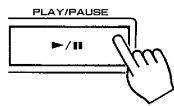

- The edited tunes are played in sequence starting with the A file. If two discs have been edited, playback continues until all the tunes in the B file of EDIT 2 are played.

■ To record an edited program

The best method is to record using the CCRS function of a KENWOOD tape deck. If this player is connected to a cassette deck which can carry out relay recording, you can record the EDIT 1 and EDIT 2 programs in succession. For details, read the "Recording from CD" section of your cassette deck's instruction manual.

■ To check the edited program contents

Press the CHECK key.

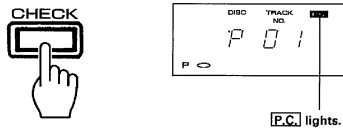

- Each press of the CHECK key displays the next tune number in the edited program sequence.

■ To erase the edited contents

Press either of these keys.

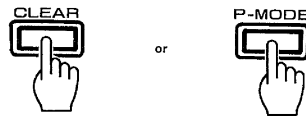

Pressing either of these keys also erases the program contents.

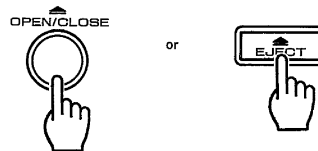

Notes:

1. If you enter a tape length different from the tape used for recording, editing will be carried out but the recorded tape may contain long unrecorded blank sections or the last tune on side A and/or B may get cut off in the middle.
2. The EDIT function can edit up to 20 tunes.
3. Editing will not be carried out properly with a disc which has only one track or a disc which contains a very long track (such as a classical music disc).

Time display and timer playing

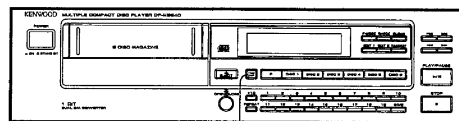

TIME DISPLAY key

■ To change time display

Each time you press the TIME DISPLAY key during any play mode, the time display changes in the order as below.

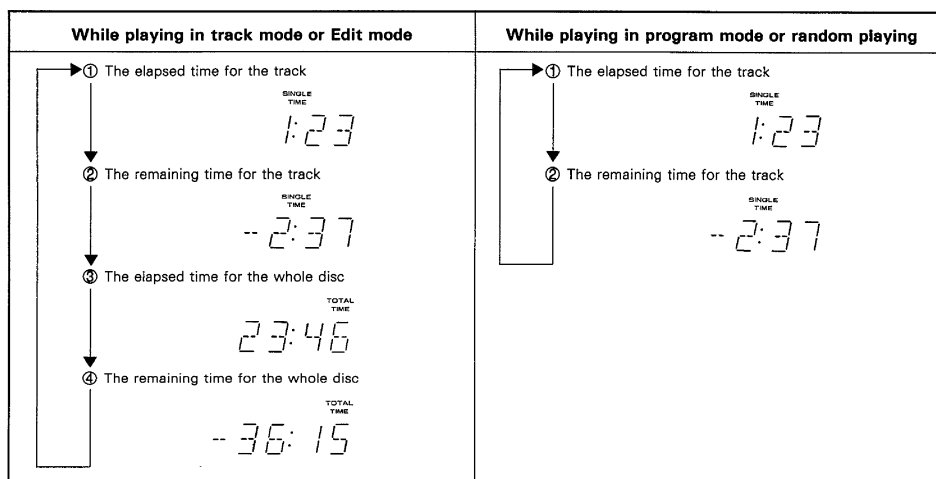

Note:
This player stores time information for up to 20 tracks on a disc. When discs having 21 or more tracks recorded on them are played the time may not be displayed. In such a case the display may show --:--.

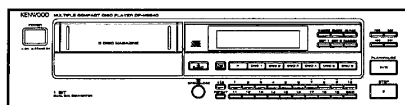

Audio timer

To wall AC outlet

■ Timer playing

Plug the CD player's AC power plug into the audio timer. Load a disc. Leave the CD player's power switch turned on and set the audio timer to the desired time.



- Play will begin from the first track on the disc. (The track mode is selected automatically when the power turns on.)

Notes:

1. Refer to the instruction manual for the timer.
2. Be careful of your amplifier volume setting when using an audio timer.
3. When operating a unit other than the CD player using an audio timer be sure to remove the disc from the CD player.

In case of difficulty

What appears to be a malfunction may not always be serious. If your unit should not perform as expected, consult the table below to see if the problem can be corrected before seeking help from your dealer or service representative.

Symptom	Cause	Remedy
No power is supplied to the player when the POWER switch is ON.	<ul style="list-style-type: none"> The power cord plug is not plugged in completely. The power cord plug is connected to a switched outlet on the amplifier and the power to the amplifier is not turned on. 	<ul style="list-style-type: none"> Insert the power cord plug firmly into the outlet. Turn on the power to the amplifier.
A disc is loaded but cannot be played.	<ul style="list-style-type: none"> The disc is loaded upside down. The disc is very dirty. The disc is scratched or damaged. The optical lens is fogged with condensation. 	<ul style="list-style-type: none"> Load the disc again, making sure that the label side is up. Clean the disc according to the instructions in the "Disc handling precautions" section. Replace the disc with a new one. Leave the unit for about several hours with the power ON so that the condensation evaporates.
No sound is produced.	<ul style="list-style-type: none"> No disc is loaded. The unit is not in play mode. (The play indicator (▶) is not lit.) The disc is very dirty. The disc is scratched or damaged. The connection cords are not securely connected. 	<ul style="list-style-type: none"> Load a disc and press the PLAY/PAUSE key . Press the PLAY/PAUSE key . Clean the disc according to the instructions in the "Disc handling precautions" section. Replace the disc with a new one. Securely connect the connection cords.
The sound skips or is interrupted.	<ul style="list-style-type: none"> The disc is very dirty. The disc is scratched or damaged. The player is subjected to vibrations. 	<ul style="list-style-type: none"> Clean the disc according to the instructions in the "Disc handling precautions" section. Replace the disc with a new one. Reinstall the unit so that it is not subjected to vibrations by moving the player to a different location, etc.
Play begins as soon as the power is turned on.	<ul style="list-style-type: none"> This unit is designed so that play begins automatically when the power is turned on if a disc is already loaded. 	<ul style="list-style-type: none"> If automatic play is not required, remove the disc from the player before turning the power OFF.

Notes:

- Since this unit incorporates a microprocessor, external noise or interference may cause the unit to operate abnormally. If this should ever occur, press the POWER switch OFF and then press it ON again after a period of several seconds.
- Do not use contact cleaner because it could cause a malfunction. Be specially careful against contact cleaners containing oil, for they may deform the plastic components.

Specifications

[Format]

System Compact disc digital audio system
Laser Semiconductor laser
Number of channels 2 channels
Playing rotation 200 rpm - 500 rpm (CLV)

[D/A Converters]

D/A conversion 1 Bit
Oversampling 4 fs

[Audio]

Frequency response 4 Hz - 20 kHz, ± 1 dB
Signal to noise ratio More than 94 dB
Dynamic range More than 92 dB
Total harmonic distortion Less than 0.005%
(at 1 kHz)

Channel separation More than 90 dB (at 1 kHz)
Wow & flutter Unmeasurable Limit
Output level/impedance
Fixed 1.2 V/3.3 k Ω

[General]

Power consumption 15 W
Dimensions W: 440 mm
H: 120 mm
D: 362 mm
Weight (Net) 5.1 kg

Note:
KENWOOD follows a policy of continuous advancements in development. For this reason specifications may be changed without notice.

English	Note:	Dansk	Bemærk:
The unit's power supply is secondarily connected. Note following. The unit is not completely disconnected from the mains as long as the power cord is connected to a wall outlet.		Strømmen til apparatet afbrydes på den sekundære side. Vær opmærksom på følgende. Denne enhed er ikke fullstendig koblet fra lysnettet så længe stikket er tilsluttet stikkontakten.	
Svenska	Observera:	Norwegian	Anmerkning:
Apparatens strömförsörjning kopplas från sekundärt. V.g. ge akt på följande. Apparaten fränkopplas inte helt och hållet från strömnätet medan apparatens nätsladd är ansluten till växelströmsuttaget.		Strømmen til apparatet er slått av på sekundærsiden. Vær oppmerksom på det følgende. Dette apparatet kopies ikke fullstendig fra nettet så lenge støpslet står i en stikkontakt, selv om strömpryteren settes i av-stilling.	
Finnish	Huom:		
Virta yksikköön on kytketty pois sekundaaripuolelta. Huomioi seuraava. Tämä yksikkö ei ole kokonaan kytketty pois pää virranjakajasta kun pää katkaisin on liitettynä virtatiiriin.			

For CANADA DOC REGULATION

"This digital apparatus does not exceed the CLASS B limits for radio noise emissions from digital apparatus as set out in the radio interference regulations of the Canadian Department of Communications."

For the U.S.A. FCC WARNING:

This equipment may generate or use radio frequency energy. Changes or modifications to this equipment may cause harmful interference unless the modifications are expressly approved in the instruction manual. The user could lose the authority to operate this equipment if an unauthorized change or modification is made.

NOTE:

This equipment has been tested and found to comply with the limits for a Class B digital device, pursuant to Part 15 of the FCC Rules. These limits are designed to provide reasonable protection against harmful interference in a residential installation. This equipment may cause harmful interference to radio communications, if it is not installed and used in accordance with the instructions. However, there is no guarantee that interference will not occur in a particular installation. If this equipment does cause harmful interference to radio or television reception, which can be determined by turning the equipment off and on, the user is encouraged to try to correct the interference by one or more of the following measures:

- Reorient or relocate the receiving antenna.
- Increase the separation between the equipment and receiver.
- Connect the equipment into an outlet on a circuit different from that to which the receiver is connected.
- Consult the dealer or an experienced radio/TV technician for help.